

## The Beadery® Sea Turtle Beady Buddy

This fun and easy craft project is the first in a series highlighting animals that are classified as endangered species. Clip this cute beaded sea turtle on your backpack and show everyone how beautiful they are and why we need to help protect them.

There are several species of sea turtle on the endangered species list. They are threatened by everything from coastal development and pollution to the fishing industry, but the biggest threat is illegal wildlife trade.

To learn more about these majestic sea creatures or to find out how you can help, please visit the Smithsonian Institution ([ocean.si.edu](http://ocean.si.edu)) or the World Wildlife Fund ([www.worldwildlife.org](http://www.worldwildlife.org)) web pages.



Our [camouflage pony bead mix](#) that is available in our online store has a good selection of colors for these turtles and the Super Value pack contains enough beads to make several Beady Buddies.

---

### Materials Needed:

68	6x9 mm Barrel Pony Beads	Brown
28	6x9 mm Barrel Pony Beads	Green
2	6x9 mm Barrel Pony Beads	Dark Brown
72" (1.9 m)	Rattail	Brown
1	1" (25 mm) Lanyard Hook	

---

### Other Tools and Items Needed:

- Scissors
  - Ruler
  - Clear Drying Craft Glue
- 

### Instructions:

**Step 1:** Cut a 72" (1.9 m) piece of brown cord. We suggest using rattail. For easier stringing, apply a dab of craft glue to each end, twist to a point and allow to dry.

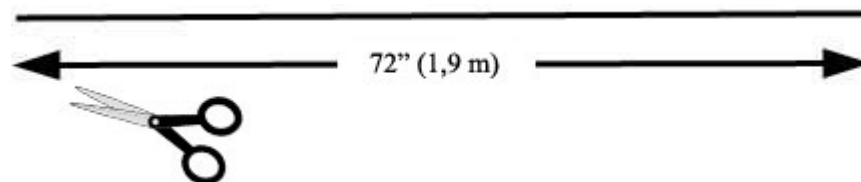

**Step 2:** String the lanyard hook onto the cord and center it. Secure with an overhand knot. You can also use a split ring if you want to make this Beaded Buddy into a keychain.



**Step 3:** String two green beads onto one end of the cord and slide up to the lanyard hook. Run the other end of the cord through the beads from the opposite side.

**NOTE:** The two halves of the cord are drawn in different colors to make the design easier to follow.

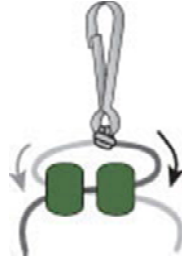

**Step 4:** String one dark brown, one green and the other dark brown bead onto one end of the cord and slide up to the previous beads. Run the other end of the cord through the beads from the opposite side.

**NOTE:** We have left the rows of beads spaced out in the illustrations to make the design easier to follow. You should pull the cord after each section to snug up the beads when you are making the project.

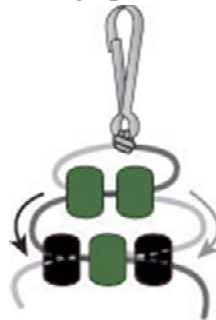

**Step 5:** Feed both cords through green beads to match the pattern below. Pull the cords to snug the beads after each row.

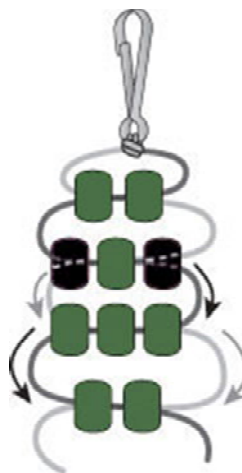

**Step 6:** String four brown beads onto one end of the cord and thread the other end through from the opposite side. Pull tight to secure beads. The brown beads will arch up over the green beads to create the shell.



**Step 7:** String one brown and five green beads onto one end of the cord. Loop the cord around and thread back through the first green bead. Slide the beads up to the body and pull tight to secure.

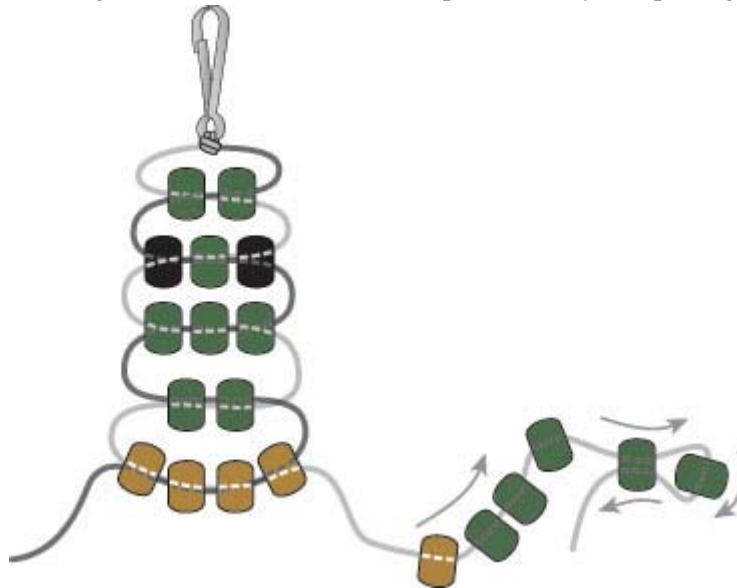

**Step 8:** String one green bead onto the cord and thread back through the first two green beads. Slide the beads up to the body and pull the cord tight secure and make a front flipper.

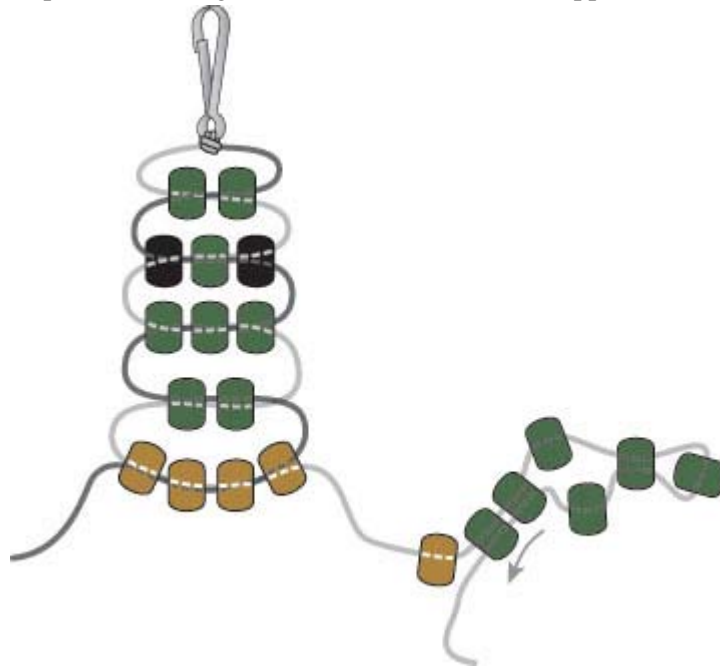

**Step 9:** Repeat Steps 7-8 with the other cord to make the second front flipper.

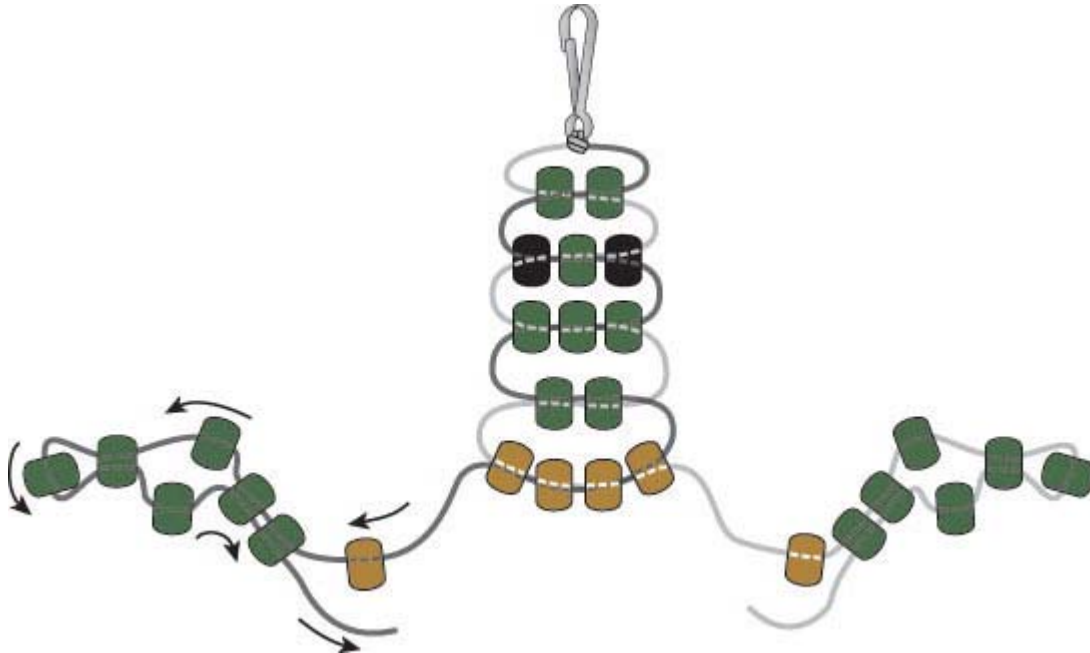



**Step 10:** String four brown beads onto one end of the cord and thread the other end through from the opposite side. Pull tight to secure beads.

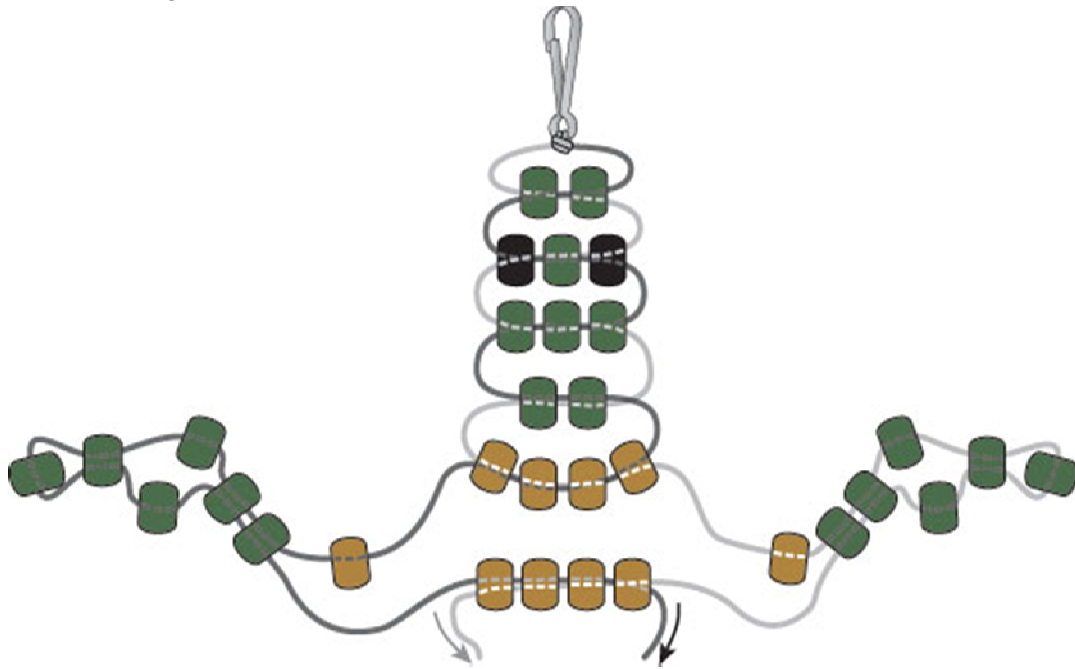

**Step 11:** String five brown beads onto one end of the cord and thread the other end through from the opposite side. Pull tight to secure beads. Make sure the brown beads are arching up on the same side as the previous arched brown section.

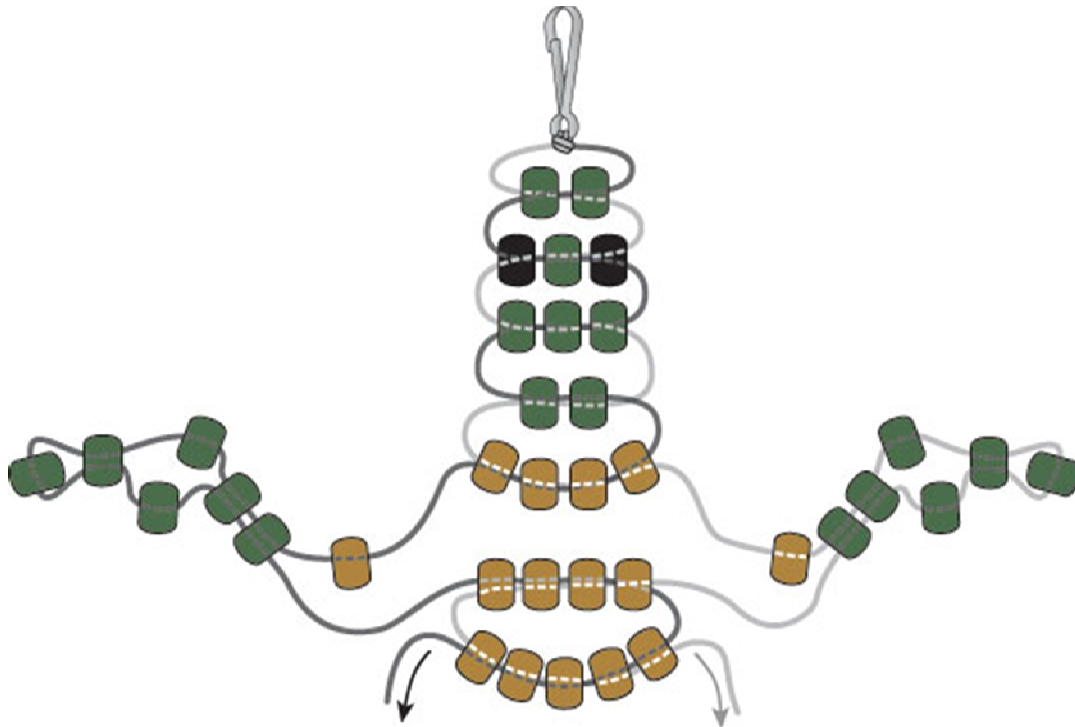

**Step 12:** String each cord end through the brown beads adjacent to the green flipper beads. Pull tight to secure beads.

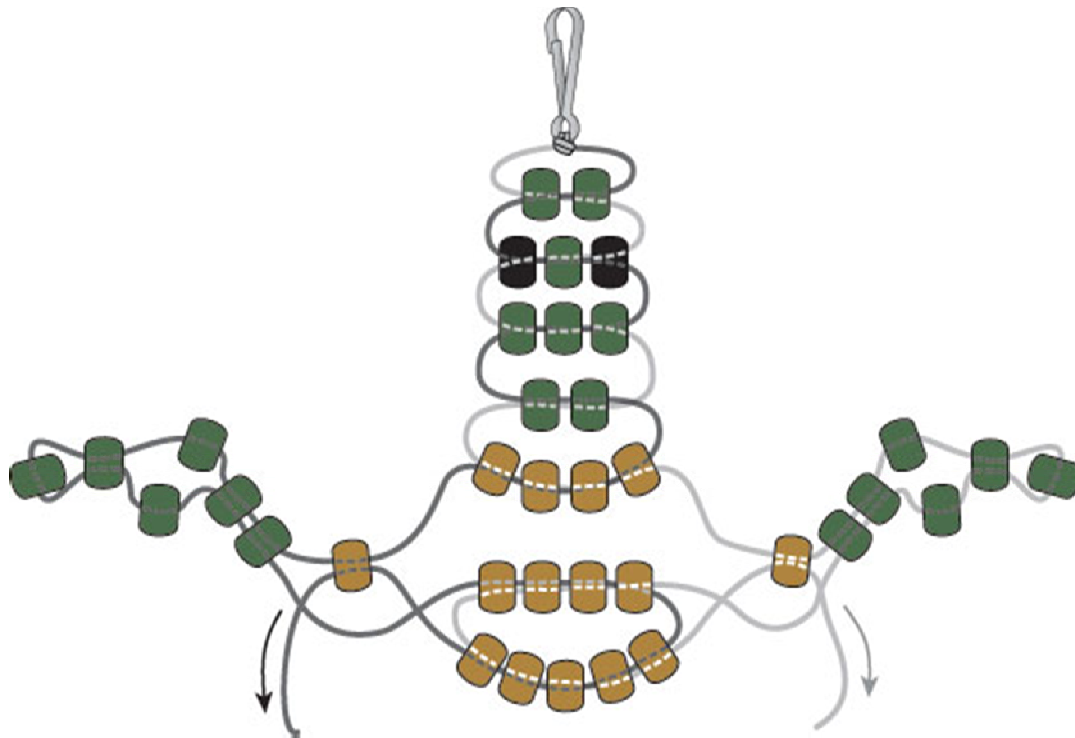

**Step 13:** String one brown pony bead onto each end of the cords and slide up to the body section.

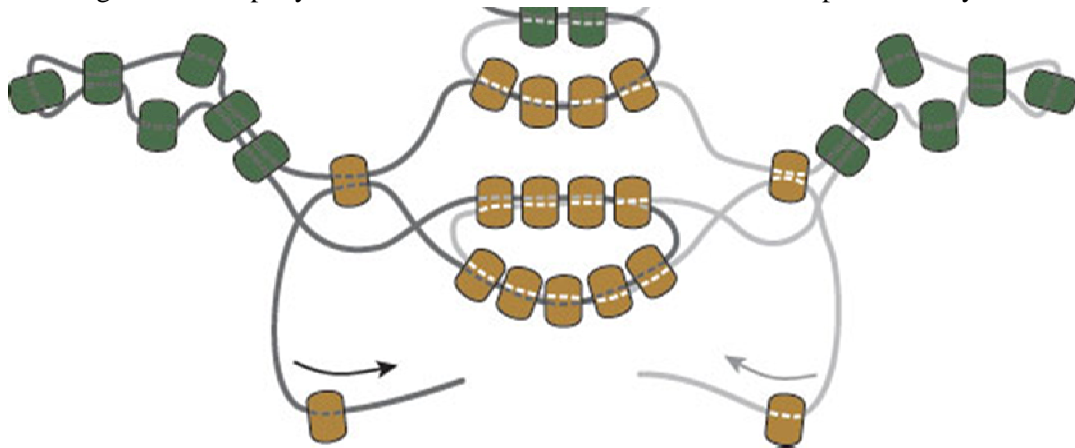

**Step 14:** String five brown beads onto one end of the cord and thread the other end through from the opposite side. Pull tight to secure beads.

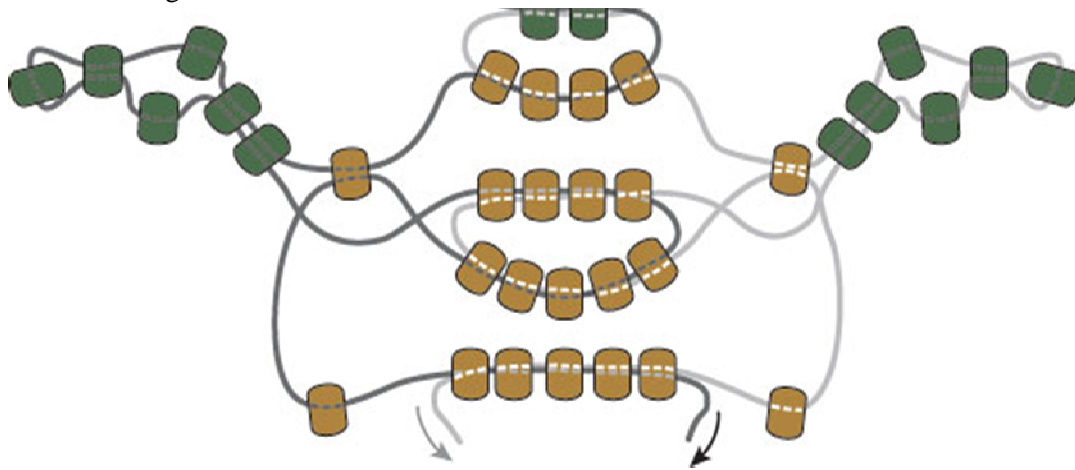

**Step 15:** String six brown beads onto one end of the cord and thread the other end through from the opposite side. Pull tight to secure beads. Make sure the brown beads are arching up on the same side as the previous arching sections. String the cord ends through the first brown beads in the section.

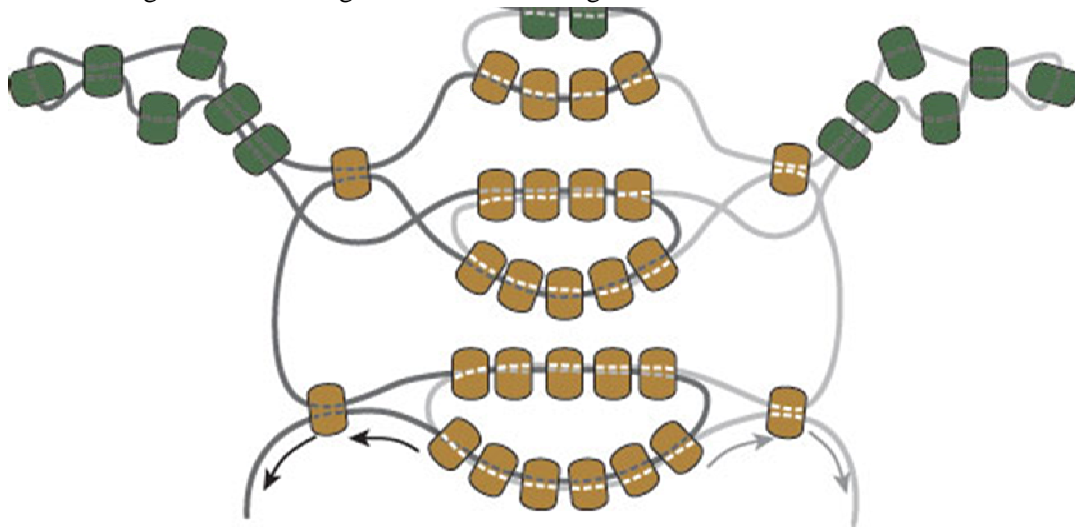

**Step 16:** Repeat *Steps 13-15* to create another section of the shell.

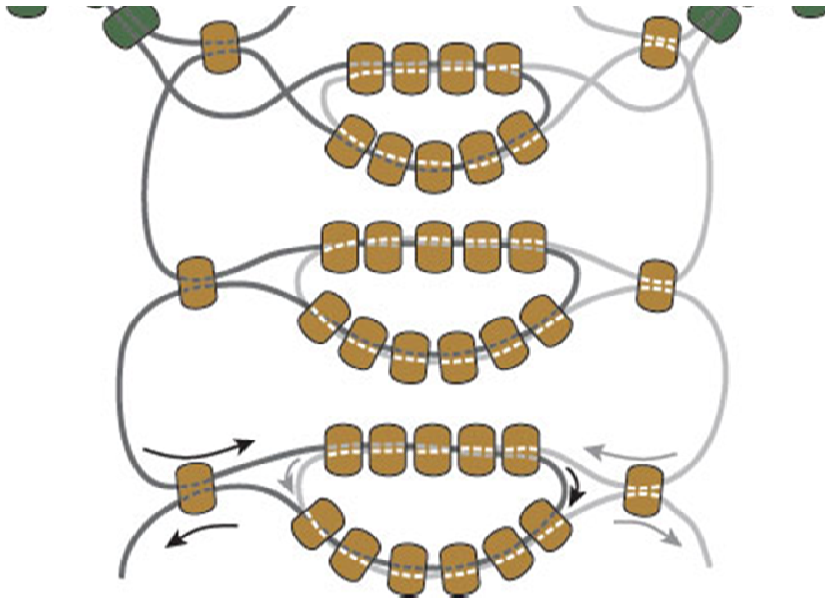

**Step 17:** String one brown pony bead onto each end of the cords and slide up to the body section.

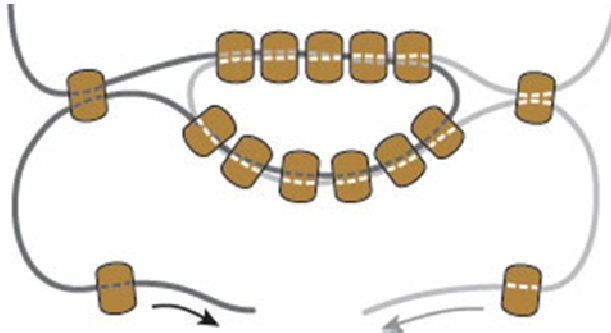

**Step 18:** String four brown beads onto one end of the cord and thread the other end through from the opposite side. Pull tight to secure beads.

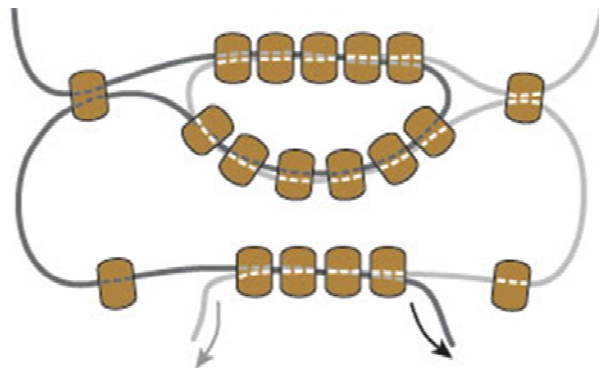

**Step 19:** String five brown beads onto one end of the cord and thread the other end through from the opposite side. Pull tight to secure beads. Make sure the brown beads are arching up on the same side as the previous brown sections. String the cord ends through the first brown beads in the section.

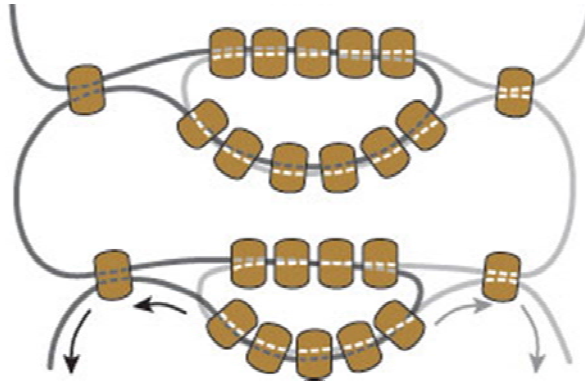

**Step 20:** String one brown pony bead onto each end of the cords and slide up to the body section.

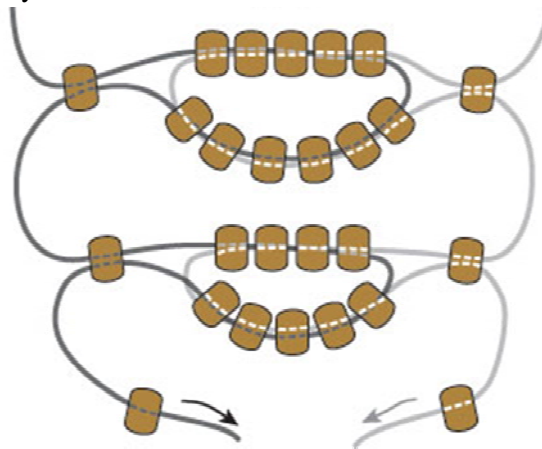

**Step 21:** String three brown beads onto one end of the cord and thread the other end through from the opposite side. Pull tight to secure beads.

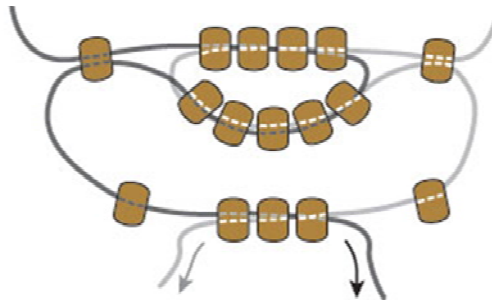

**Step 22:** String four brown beads onto one end of the cord and thread the other end through from the opposite side. Pull tight to secure beads. Make sure the brown beads are arching up on the same side as the previous brown sections. String the cord ends through the first brown beads in the section.

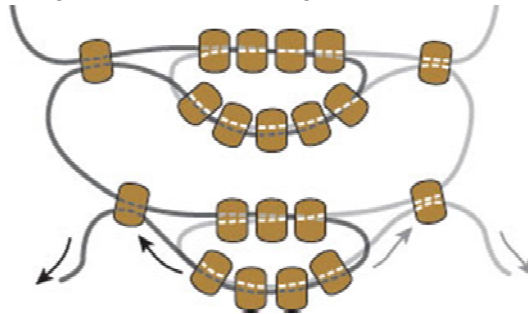

**Step 23:** String four green beads onto one end of the cord. Loop the cord around and thread back through the first green bead to form a rear flipper. Pull tight to secure beads.

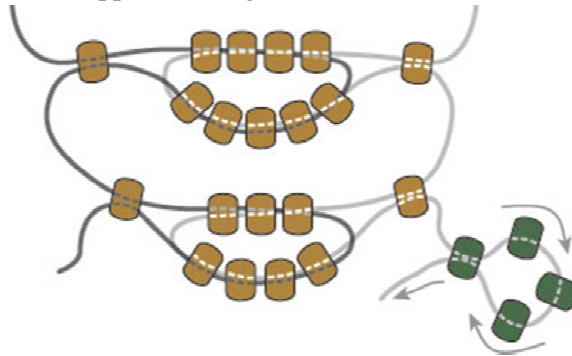

**Step 24:** Repeat Step 23 with the other cord to make the second back flipper.

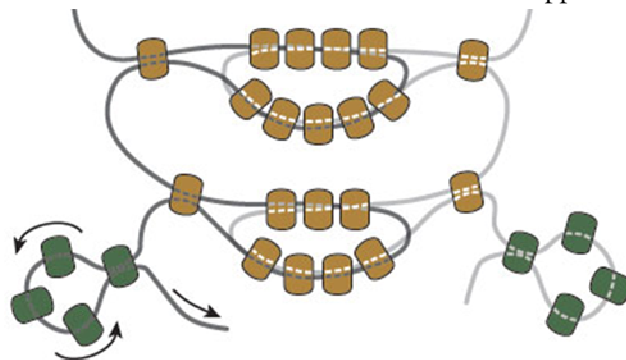

**Step 25:** String a brown pony bead onto each cord end and slide up to the body.

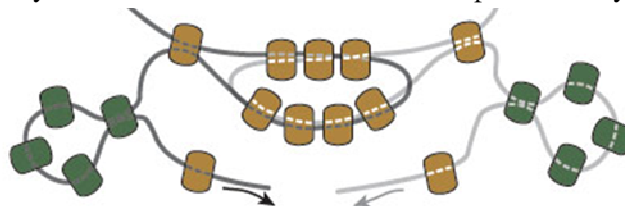



**Step 26:** String one brown bead onto one end of the cord and thread the other end through from the opposite side. Pull tight to secure beads.

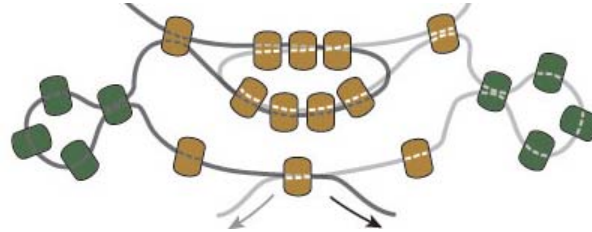

**Step 27:** String two brown beads onto one end of the cord and thread the other end through from the opposite side. Make sure the brown beads are arching up on the same side as the previous brown sections.

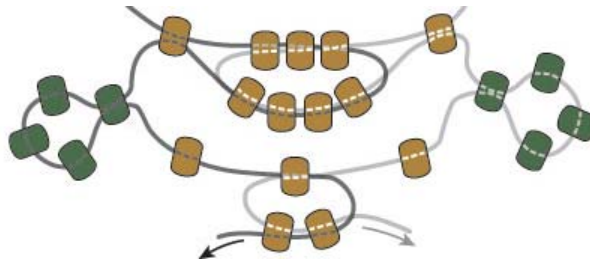

**Step 28:** String each cord through the first brown pony bead in the shell section from the outside. Pull tight to secure beads.

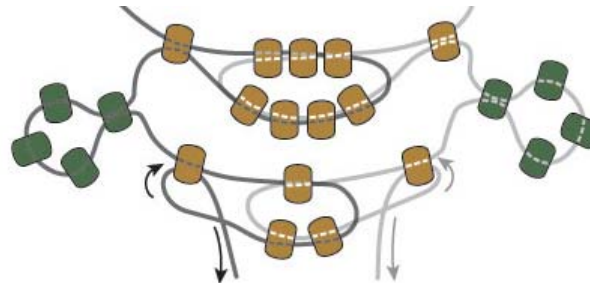

**Step 29:** String two brown beads onto one end of the cord and thread the other end through from the opposite side. Pull tight to secure beads.

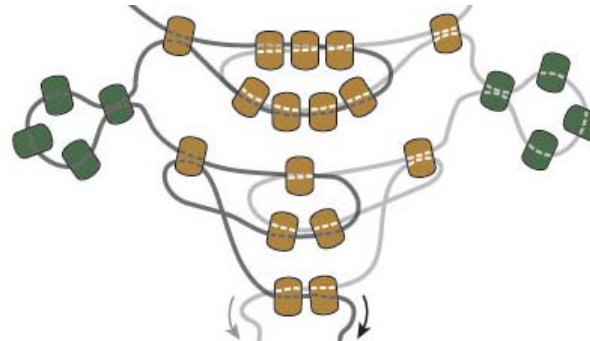

**Step 30:** Pull the cords to snug the beads up together and tie a knot. Apply a dab of craft glue to the knot to secure and trim off excess.

